

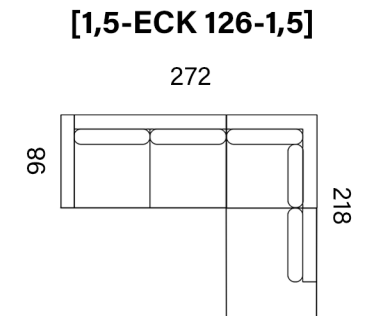

PRZYKŁADOWE UKŁADY

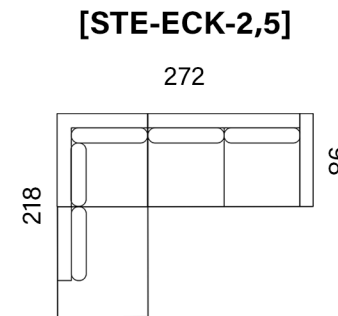

BRYŁY DO UKŁADÓW / ELEMENTS

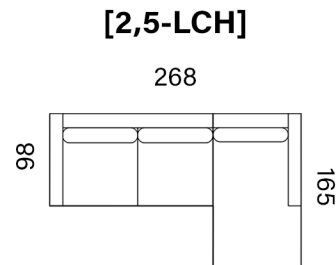
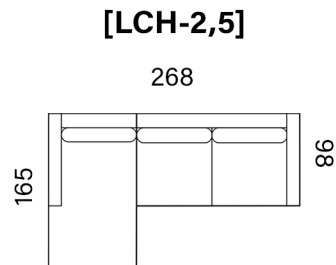
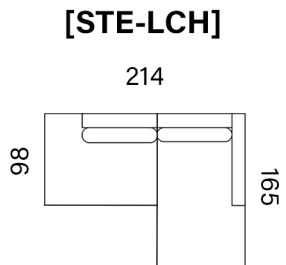
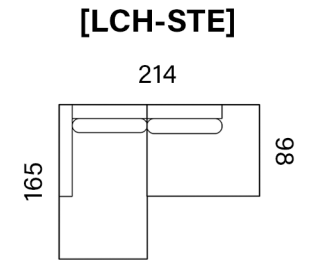
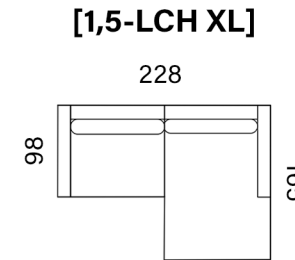
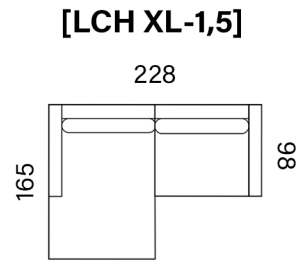
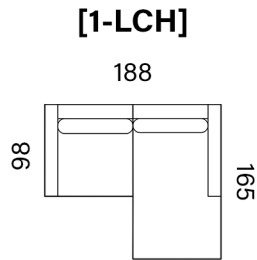
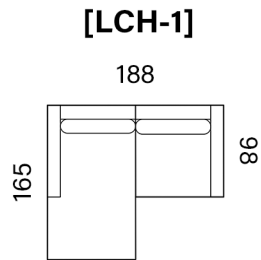
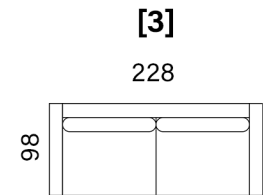
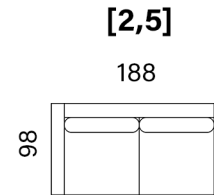
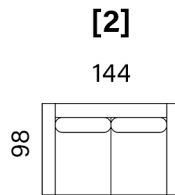
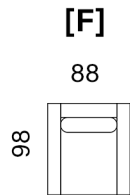
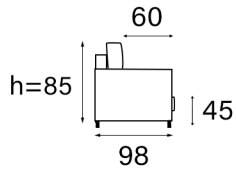
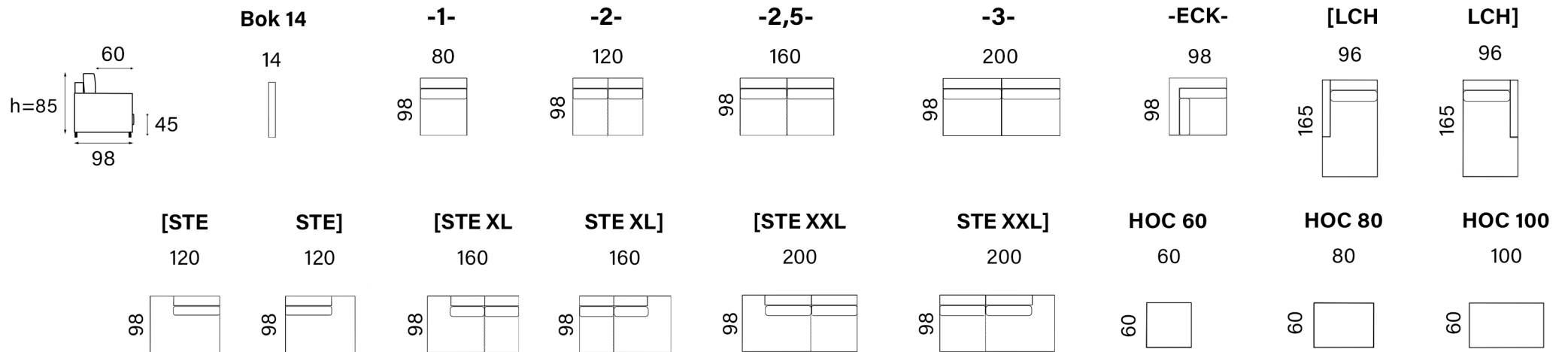

OPIS MEBLA

STELAŻ wykonany z elementów drewna liściastego, iglastego, płyty MFP oraz sklejk.

SIEDZENIE na sprężynach falistych fi 3,8 mm i zaczepach RapidClip. Wypełnione pianką poliuretanową HR3532 oraz kołderka wypełniona mikro włóknem poliestrowym.

PODUSZKI OPARCIA wypełniona mikro włóknem poliestrowym.

MODEL DESCRIPTION

FRAME made of hardwood, coniferous, MFP board and plywood.

SEAT CUSHION on fi 3.8 mm corrugated springs and RapidClip hooks. Filled with HR 3532 polyurethane foam and a duvet filled with polyester micro fiber.

BACK CUSHION filled with polyester micro fiber.

